

NCV8669

Very Low I_q 150 mA LDO Regulator with Reset and Early Warning

The NCV8669 is 150 mA LDO regulator with integrated reset and early warning functions dedicated for microprocessor applications. Its robustness allows NCV8669 to be used in severe automotive environments. The NCV8669 utilizes precise 1 M Ω internal resistor divider for Early Warning function which significantly reduces overall application quiescent current and number of external components. Very low quiescent current as low as 42 μ A typical for NCV8669 makes it suitable for applications permanently connected to battery requiring very low quiescent current with or without load. The NCV8669 contains protection functions as current limit and thermal shutdown.

Features

- Output Voltage Options: 5 V
- Output Voltage Accuracy: $\pm 2\%$
- Output Current up to 150 mA
- Very Low Quiescent Current: Typ 42 μ A (Including Internal Early Warning Resistor Divider Current)
- Very Low Dropout Voltage
- Early Warning Threshold Accuracy: $\pm 10\%$ Over Temperature Range (Using R_{SI_ext} External Resistor with $\pm 1\%$ 100 ppm/ $^{\circ}$ C)
- Microprocessor Compatible Control Functions:
 - ◆ Reset with Adjustable Power-on Delay
 - ◆ Early Warning
- Wide input voltage operation range: up to 40 V
- Protection Features:
 - ◆ Current Limitation
 - ◆ Thermal Shutdown
- These are Pb-Free Devices

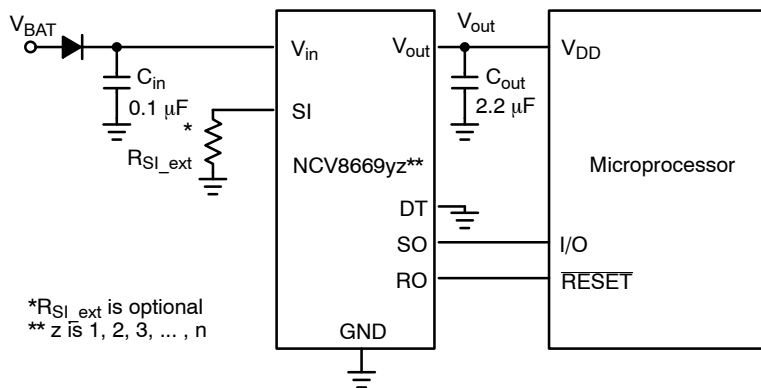

Figure 1. Application Circuit



ON Semiconductor®

<http://onsemi.com>

MARKING DIAGRAM

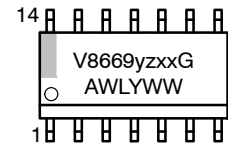

- y = Timing and Reset Threshold Option*
- z = Early Warning Option*
- xx = Voltage Option
5.0 V (xx = 50)
- A = Assembly Location
- WL = Wafer Lot
- Y = Year
- WW = Work Week
- G = Pb-Free Package

*See APPLICATION INFORMATION section.

ORDERING INFORMATION

See detailed ordering and shipping information in the dimensions section on page 13 of this data sheet.

Typical Applications

- Body Control Module
- Instruments and Clusters
- Occupant Protection and Comfort
- Powertrain

NCV8669

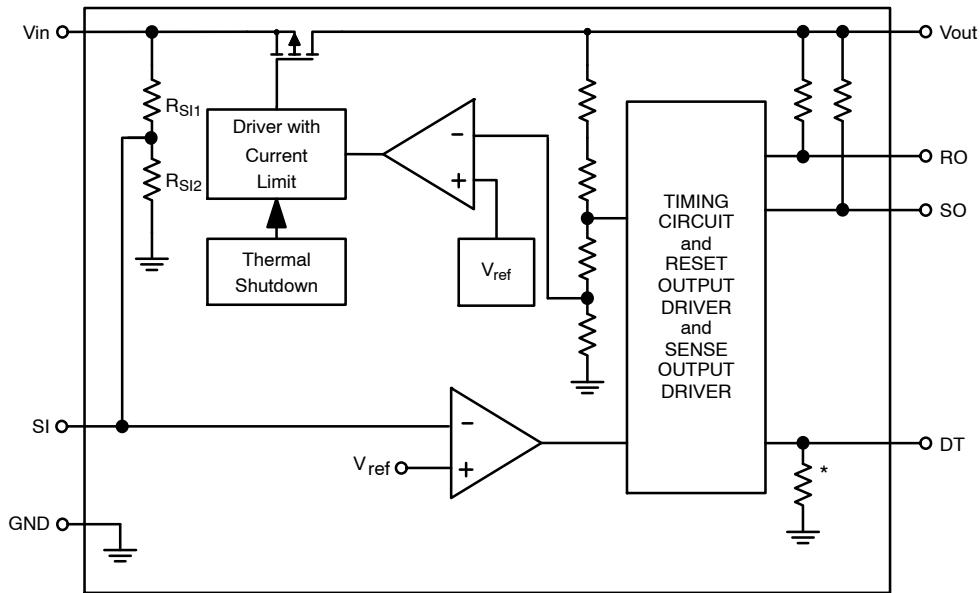

*Pull-down Resistor (typ 150 kΩ) active only in Reset State.

Figure 2. Simplified Block Diagram

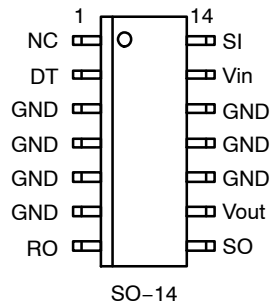

Figure 3. Pin Connections
(Top View)

PIN FUNCTION DESCRIPTION

Pin No. SO-14	Pin Name	Description
1	NC	Not Connected.
2	DT	Reset Delay Time Select. Short to GND or connect to V_{out} to select time.
3, 4, 5, 6, 10, 11, 12	GND	Power Supply Ground.
7	RO	Reset Output. 30 kΩ internal Pull-Up resistor connected to V_{out} . RO goes Low when V_{out} drops by more than 7% (typ.) from its nominal value.
8	SO	Early Warning Output. 30 kΩ internal Pull-Up resistor connected to V_{out} . It can be used to provide early warning of an impending reset condition. Leave open if not used.
9	V_{out}	Regulated Output Voltage. Connect 2.2 μF capacitor with ESR < 100 Ω to ground.
13	V_{in}	Positive Power Supply Input. Connect 0.1 μF capacitor to ground.
14	SI	Early Warning Adjust Input; connect R_{SI_ext} against GND to adjust Input Voltage Early Warning Threshold or leave unconnected. See Electrical Characteristics Table and Application Information sections for more information.

ABSOLUTE MAXIMUM RATINGS

Rating	Symbol	Min	Max	Unit
Input Voltage DC (Note 1) DC Transient, t < 100 ms	V _{in}	-0.3 -	40 45	V
Input Current	I _{in}	-5	-	mA
Output Voltage (Note 2)	V _{out}	-0.3	5.5	V
Output Current	I _{out}	-3	Current Limited	mA
Sense Input Voltage DC DC Transient, t < 100 ms	V _{SI}	-0.3 -	40 45	V
Sense Input Current Range	I _{SI}	-1	1	mA
DT (Reset Delay Time Select) Voltage	V _{DT}	-0.3	5.5	V
DT (Reset Delay Time Select) Current	I _{DT}	-1	1	mA
Reset Output Voltage	V _{RO}	-0.3	5.5	V
Reset Output Current	I _{RO}	-3	3	mA
Sense Output Voltage	V _{SO}	-0.3	5.5	V
Sense Output Current	I _{SO}	-3	3	mA
Junction Temperature	T _J	-40	150	°C
Storage Temperature	T _{STG}	-55	150	°C

Stresses exceeding Maximum Ratings may damage the device. Maximum Ratings are stress ratings only. Functional operation above the Recommended Operating Conditions is not implied. Extended exposure to stresses above the Recommended Operating Conditions may affect device reliability.

1. Refer to ELECTRICAL CHARACTERISTICS and APPLICATION INFORMATION for Safe Operating Area.
2. 5.5 or (V_{in} + 0.3 V), whichever is lower

ESD CAPABILITY (Note 3)

Rating	Symbol	Min	Max	Unit
ESD Capability, Human Body Model	ESD _{HBM}	-2	2	kV
ESD Capability, Machine Model	ESD _{MM}	-200	200	V
ESD Capability, Charged Device Model	ESD _{CDM}	-1	1	kV

3. This device series incorporates ESD protection and is tested by the following methods:
ESD Human Body Model tested per AEC-Q100-002 (JS-001-2010)
ESD Machine Model tested per AEC-Q100-003 (EIA/JESD22-A115)
ESD Charged Device Model tested per AEC-Q100-011 (EIA/JESD22-C101)

LEAD SOLDERING TEMPERATURE AND MSL (Note 4)

Rating	Symbol	Min	Max	Unit
Moisture Sensitivity Level	MSL	1		-
Lead Temperature Soldering Reflow (SMD Styles Only), Pb-Free Versions	T _{SLD}	-	265 peak	°C

4. For more information, please refer to our Soldering and Mounting Techniques Reference Manual, SOLDERRM/D

THERMAL CHARACTERISTICS (Note 5)

Rating	Symbol	Value	Unit
Thermal Characteristics Thermal Resistance, Junction-to-Air (Note 6) Thermal Reference, Junction-to-Lead (Note 6)	R _{θJA} R _{ψJL}	94 18	°C/W

5. Refer to ELECTRICAL CHARACTERISTICS and APPLICATION INFORMATION for Safe Operating Area.
6. Values based on copper area of 645 mm² (or 1 in²) of 1 oz copper thickness and FR4 PCB substrate.

NCV8669

OPERATING RANGES (Note 7)

Rating	Symbol	Min	Max	Unit
Input Voltage (Note 7)	V_{in}	5.5	40	V
Junction Temperature	T_J	-40	150	°C

7. Refer to ELECTRICAL CHARACTERISTICS and APPLICATION INFORMATION for Safe Operating Area.

8. Minimum $V_{in} = 5.5$ V or ($V_{out} + V_{DO}$), whichever is higher.

ELECTRICAL CHARACTERISTICS $V_{in} = 13.2$ V, $V_{DT} = GND$, R_{SI_ext} not used, $C_{in} = 0.1$ μ F, $C_{out} = 2.2$ μ F, for typical values $T_J = 25^\circ$ C, for min/max values $T_J = -40^\circ$ C to 150° C; unless otherwise noted. (Notes 9 and 10)

Parameter	Test Conditions	Symbol	Min	Typ	Max	Unit
-----------	-----------------	--------	-----	-----	-----	------

REGULATOR OUTPUT

Output Voltage (Accuracy %)	$V_{in} = 5.6$ V to 40 V, $I_{out} = 0.1$ mA to 100 mA $V_{in} = 5.8$ V to 16 V, $I_{out} = 0.1$ mA to 150 mA	V_{out}	4.9 4.9 (-2%)	5.0 5.0	5.1 5.1 (+2%)	V
Output Voltage (Accuracy %)	$T_J = -40^\circ$ C to 125° C $V_{in} = 5.8$ V to 28 V, $I_{out} = 0$ mA to 150 mA	V_{out}	4.9 (-2%)	5.0	5.1 (+2%)	V
Line Regulation	$V_{in} = 6$ V to 28 V, $I_{out} = 5$ mA	Reg_{line}	-20	0	20	mV
Load Regulation	$I_{out} = 0.1$ mA to 150 mA	Reg_{load}	-40	10	40	mV
Dropout Voltage (Note 11)	$I_{out} = 100$ mA $I_{out} = 150$ mA	V_{DO}	-	225 300	450 600	mV
Output Capacitor for Stability (Note 12)	$I_{out} = 0$ mA to 150 mA	C_{out} ESR	2.2 0.01	- -	100 100	μ F Ω

QUIESCENT CURRENT

Quiescent Current, $I_q = I_{in} - I_{out}$ (Note 13)	$I_{out} = 0.1$ mA, $T_J = 25^\circ$ C $I_{out} = 0.1$ mA to 150 mA, $T_J \leq 125^\circ$ C	I_q	- -	42	49 50	μ A
---	--	-------	--------	----	----------	---------

CURRENT LIMIT PROTECTION

Current Limit	$V_{out} = 0.96 \times V_{out_nom}$	I_{LIM}	205	-	525	mA
Short Circuit Current Limit	$V_{out} = 0$ V	I_{SC}	205	-	525	mA

PSRR

Power Supply Ripple Rejection (Note 12)	$f = 100$ Hz, $0.5 V_{pp}$	PSRR	-	60	-	dB
---	----------------------------	------	---	----	---	----

DT (Reset Delay Time Select)

DT Threshold Voltage Logic Low Logic High		$V_{th(DT)}$	- 2	- -	0.8 -	V
DT Input Current	$V_{DT} = 5$ V	I_{DT}	-	-	1	μ A

RESET OUTPUT RO

Output Voltage Reset Threshold (Note 14)	V_{out} decreasing $V_{in} > 5.5$ V	V_{RT}	90	93	96	% V_{out}
Reset Hysteresis		V_{RH}	-	2.0	-	% V_{out}
Maximum Reset Sink Current	$V_{out} = 4.5$ V, $V_{RO} = 0.25$ V	I_{ROmax}	1.75	-	-	mA

9. Refer to ABSOLUTE MAXIMUM RATINGS and APPLICATION INFORMATION for Safe Operating Area.

10. Performance guaranteed over the indicated operating temperature range by design and/or characterization tested at $T_A \approx T_J$. Low duty cycle pulse techniques are used during testing to maintain the junction temperature as close to ambient as possible.

11. Measured when output voltage falls 100 mV below the regulated voltage at $V_{in} = 13.2$ V.

12. Values based on design and/or characterization.

13. I_q for Preset EW Threshold Options is measured when R_{SI_ext} is not used. For typical values of I_q vs R_{SI_ext} see Figure 23.

14. See APPLICATION INFORMATION section for Reset Thresholds and Reset Delay Time Options

NCV8669

ELECTRICAL CHARACTERISTICS $V_{in} = 13.2\text{ V}$, $V_{DT} = \text{GND}$, R_{SI_ext} not used, $C_{in} = 0.1\ \mu\text{F}$, $C_{out} = 2.2\ \mu\text{F}$, for typical values $T_J = 25^\circ\text{C}$, for min/max values $T_J = -40^\circ\text{C}$ to 150°C ; unless otherwise noted. (Notes 9 and 10)

Parameter	Test Conditions	Symbol	Min	Typ	Max	Unit
-----------	-----------------	--------	-----	-----	-----	------

RESET OUTPUT RO

Reset Output Low Voltage	$V_{out} > 1\text{ V}$, $I_{RO} < 200\ \mu\text{A}$	V_{ROL}	-	0.15	0.25	V
Reset Output High Voltage		V_{ROH}	4.5	-	-	V
Integrated Reset Pull Up Resistor		R_{RO}	15	30	50	k Ω
Reset Delay Time (Note 14)	DT connected to GND DT connected to V_{out}	t_{RD}	12.8 25.6	16 32	19.2 38.4	ms
Reset Reaction Time (see Figure 24)		t_{RR}	16	25	38	μs

EARLY WARNING (SI and SO)

Early Warning Input Voltage Threshold (Preset EW Threshold Values) NCV8669y2 High Low	$R_{SI1} = 480\ \text{k}\Omega$, $R_{SI2} = 520\ \text{k}\Omega$ (internal resistor divider values, see) $R_{SI_ext} = 150\ \text{k}\Omega$ ($\pm 1\%$, $\pm 100\ \text{ppm}/^\circ\text{C}$) (external resistor value, see Figure 22)	$V_{in_EW(th)}$	5.67 5.30	6.30 5.89	6.92 6.47	V
Integrated Sense Output Pull Up Resistor		R_{SO}	15	30	50	k Ω
Sense Output Low Voltage	$V_{in} < V_{in_EW(th)_Low_Min}$, $I_{SO} < 200\ \mu\text{A}$, $V_{out} > 1\text{ V}$	V_{SOL}	-	0.15	0.25	V
Sense Output High Voltage		V_{SOH}	4.5	-	-	V
Maximum Sense Output Sink Current	$V_{SO} = 0.25\text{ V}$ $V_{in} < V_{in_EW(th)_Low_Min}$ $V_{out} = 4.5\text{ V}$	I_{SOmax}	1.75	-	-	mA

THERMAL SHUTDOWN

Thermal Shutdown Temperature (Note 12)		T_{SD}	150	175	195	$^\circ\text{C}$
Thermal Shutdown Hysteresis (Note 12)		T_{SH}	-	25	-	$^\circ\text{C}$

9. Refer to ABSOLUTE MAXIMUM RATINGS and APPLICATION INFORMATION for Safe Operating Area.
10. Performance guaranteed over the indicated operating temperature range by design and/or characterization tested at $T_A \approx T_J$. Low duty cycle pulse techniques are used during testing to maintain the junction temperature as close to ambient as possible.
11. Measured when output voltage falls 100 mV below the regulated voltage at $V_{in} = 13.2\text{ V}$.
12. Values based on design and/or characterization.
13. I_q for Preset EW Threshold Options is measured when R_{SI_ext} is not used. For typical values of I_q vs R_{SI_ext} see Figure 23.
14. See APPLICATION INFORMATION section for Reset Thresholds and Reset Delay Time Options

TYPICAL CHARACTERISTICS

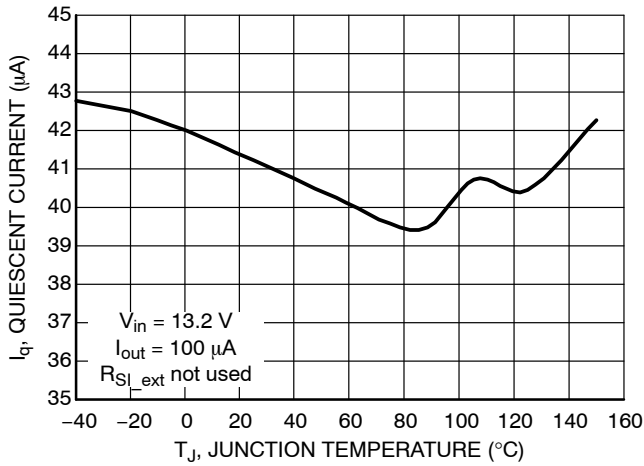

Figure 4. Quiescent Current vs. Temperature

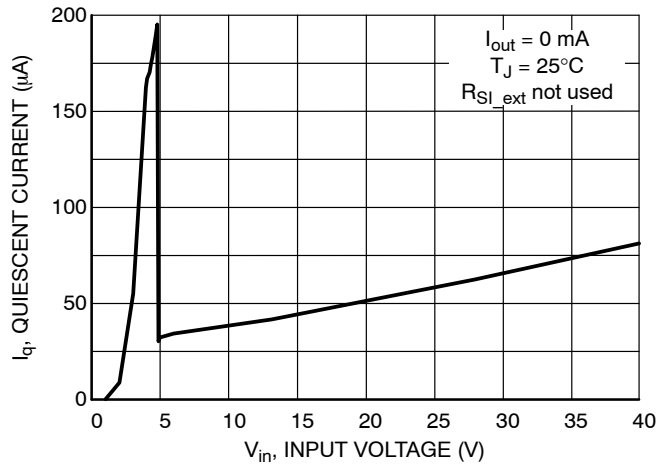

Figure 5. Quiescent Current vs. Input Voltage

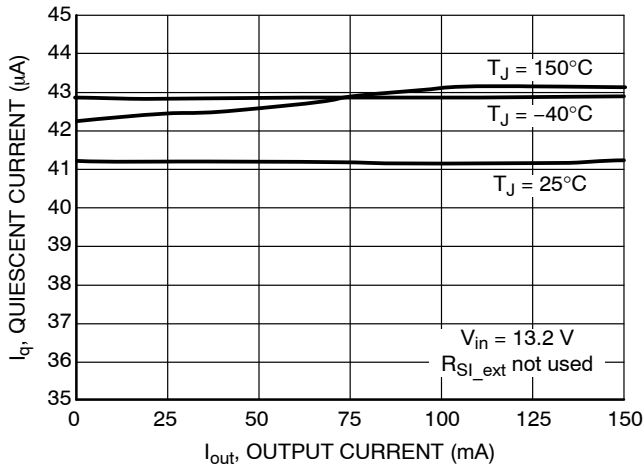

Figure 6. Quiescent Current vs. Output Current

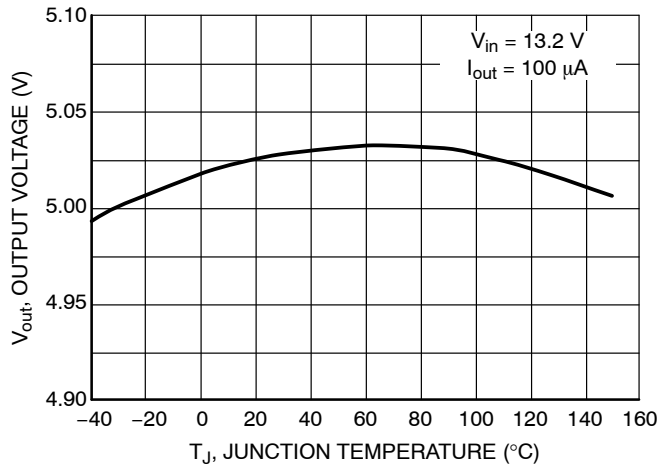

Figure 7. Output Voltage vs. Temperature

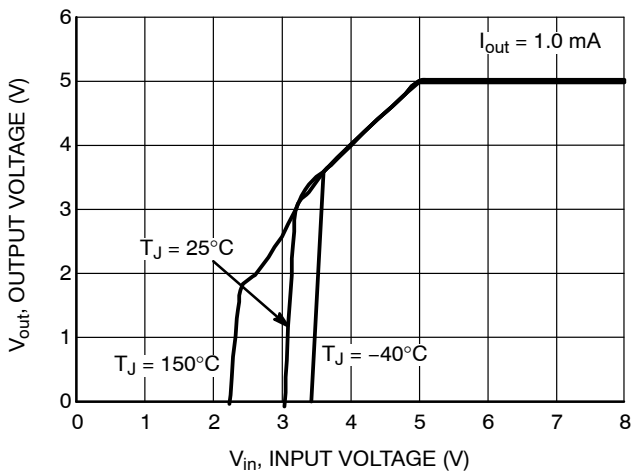

Figure 8. Output Voltage vs. Input Voltage

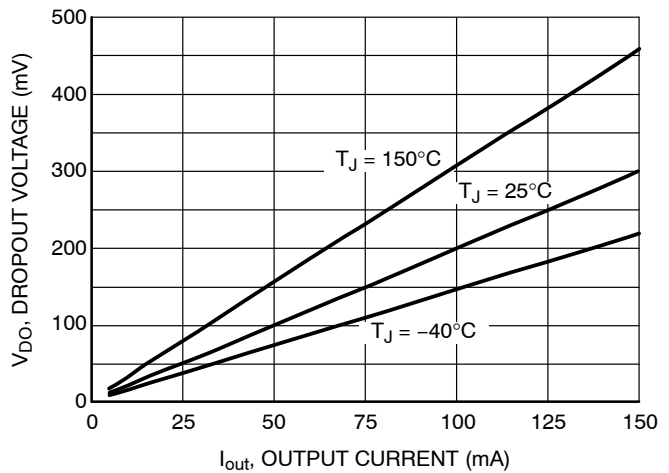

Figure 9. Dropout vs. Output Current

TYPICAL CHARACTERISTICS

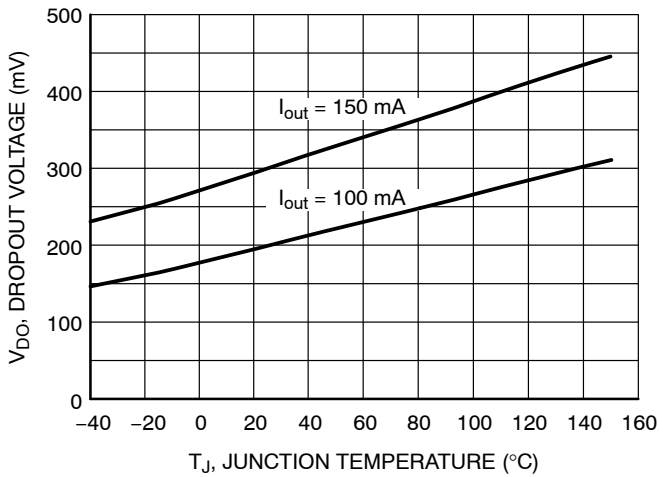

Figure 10. Dropout vs. Temperature

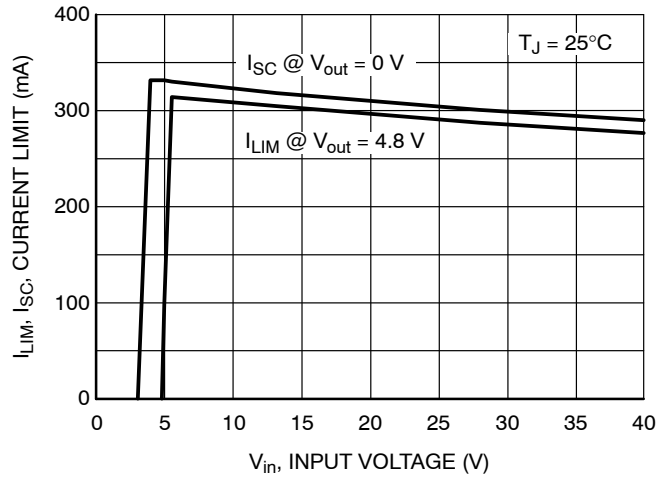

Figure 11. Output Current Limit vs. Input Voltage

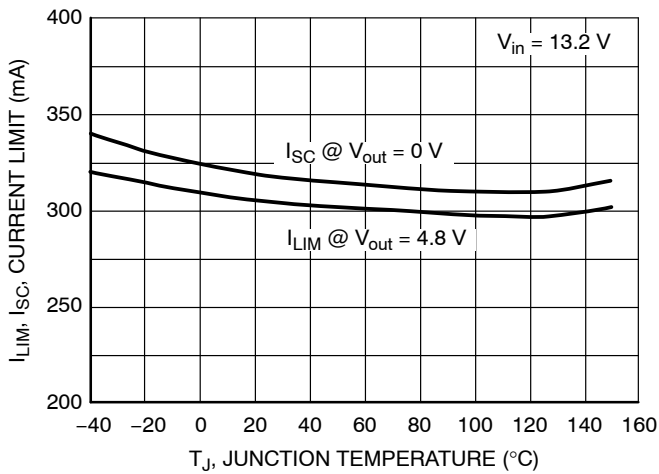

Figure 12. Output Current Limit vs. Temperature

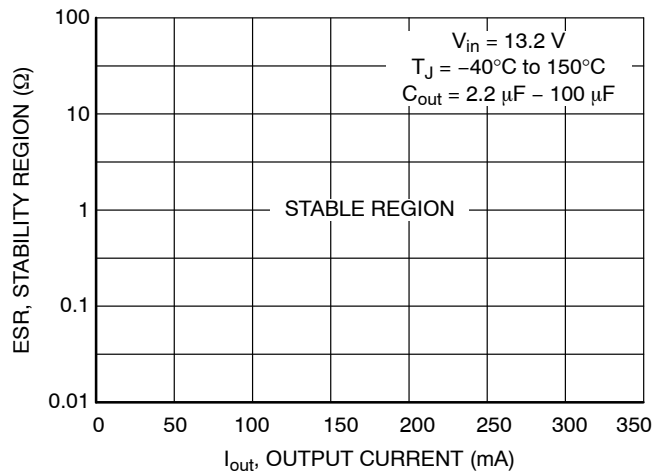

Figure 13. C_{out} ESR Stability vs. Output Current

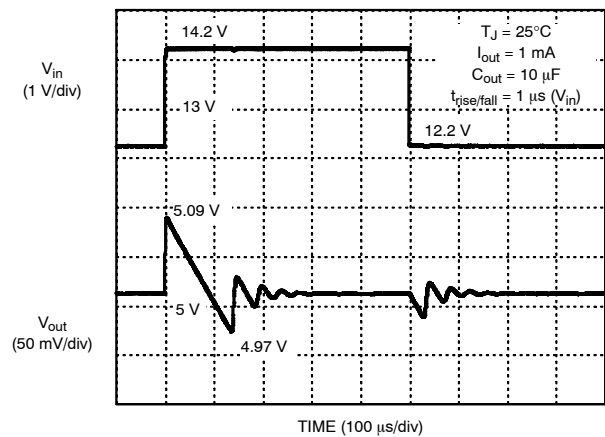

Figure 14. Line Transients

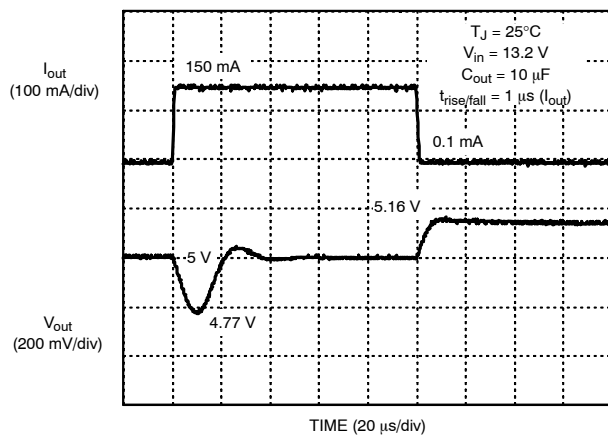

Figure 15. Load Transients

TYPICAL CHARACTERISTICS

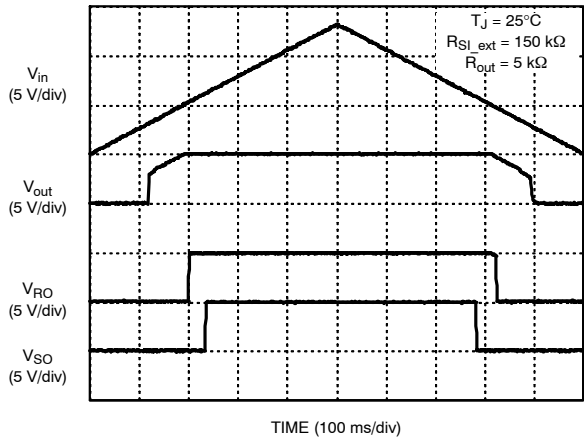

Figure 16. Power Up and Down Transient

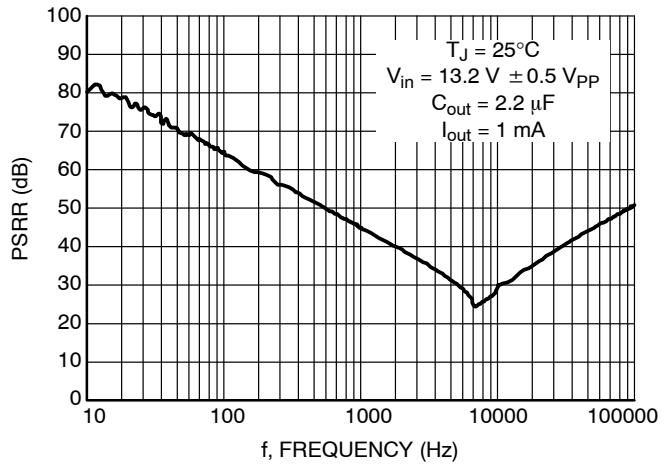

Figure 17. PSRR vs. Frequency

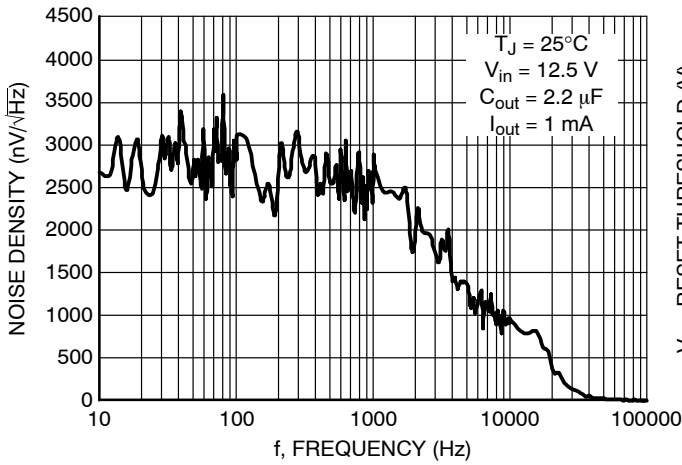

Figure 18. Noise Density vs. Frequency

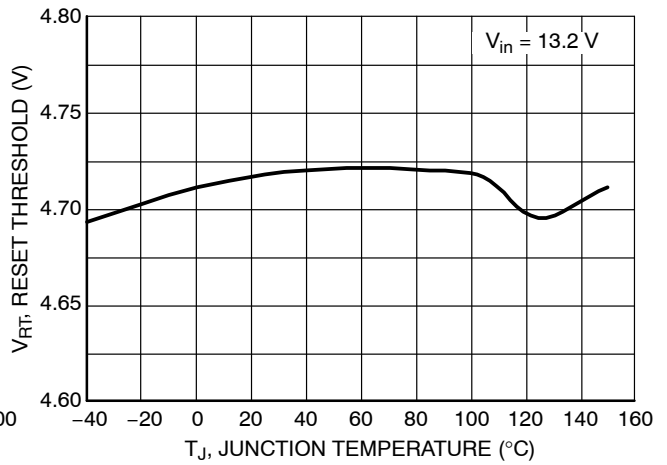

Figure 19. Reset Threshold vs. Temperature

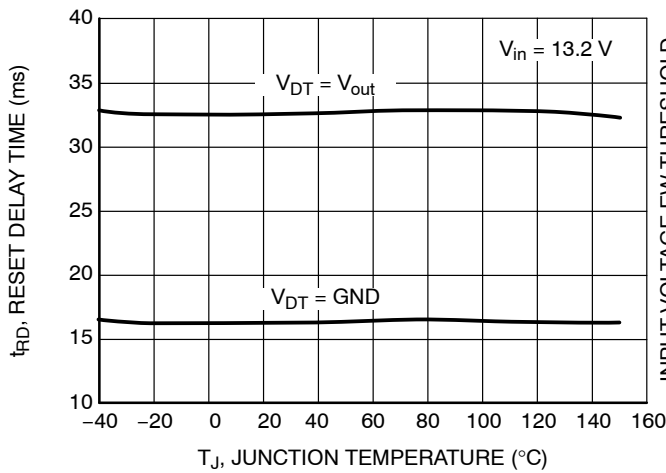

Figure 20. Reset Delay Times vs. Temperature

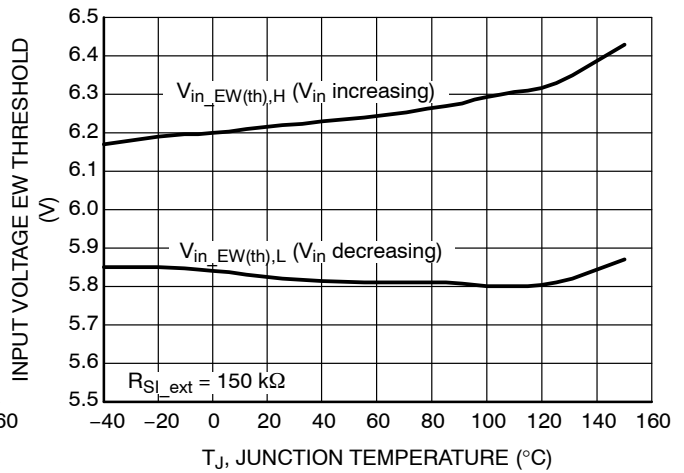

Figure 21. V_{in} EW Thresholds vs. Temperature

TYPICAL CHARACTERISTICS

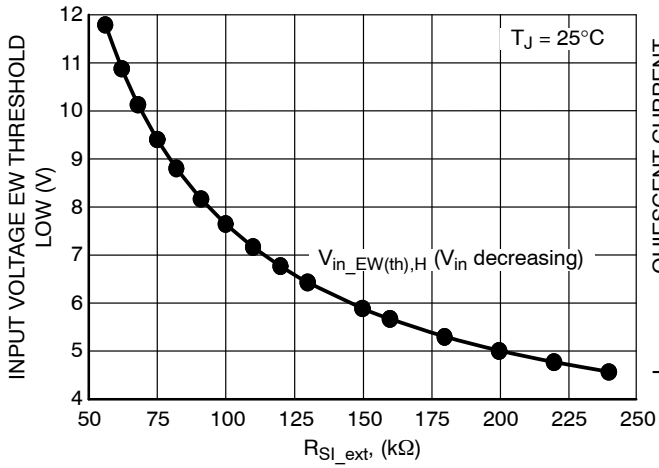

Figure 22. Input Voltage EW Threshold Low vs. R_{Sl_ext} (Calculated Using E24 Series)

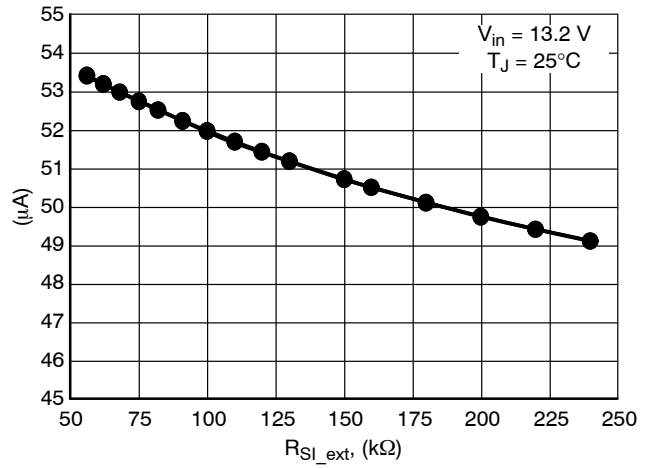

Figure 23. Quiescent Current vs. R_{Sl_ext} (Including I_{RSl_ext} , Calculated Using E24 Series)

NCV8669

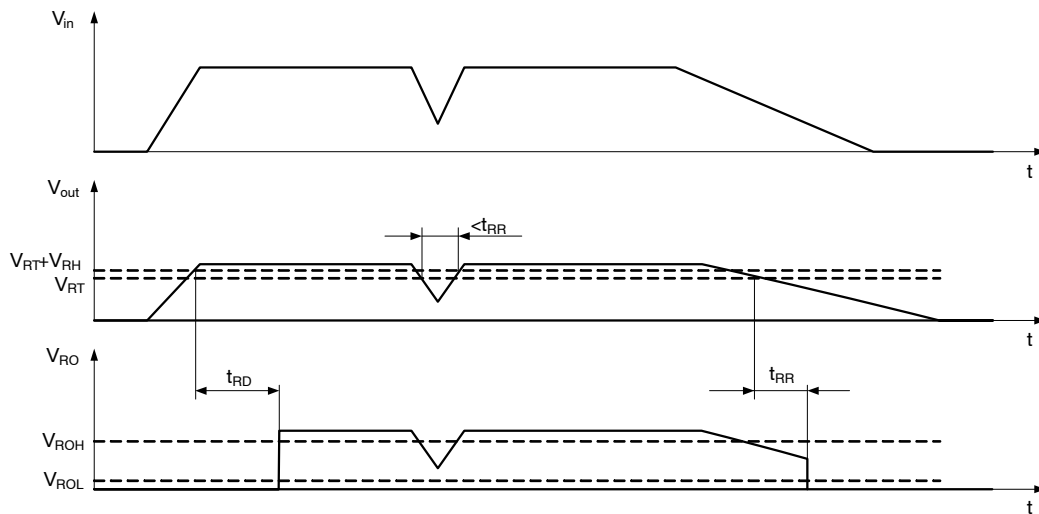

Figure 24. Reset Function and Timing Diagram

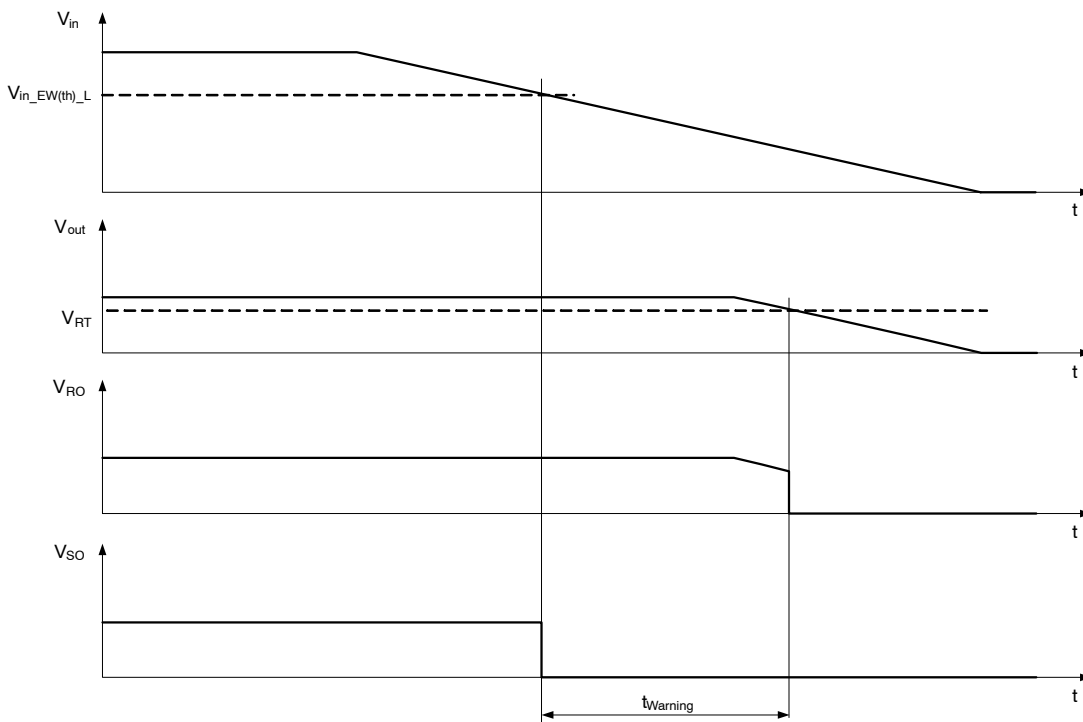

Figure 25. Input Voltage Early Warning Function Diagram

DEFINITIONS

General

All measurements are performed using short pulse low duty cycle techniques to maintain junction temperature as close as possible to ambient temperature.

Output Voltage

The output voltage parameter is defined for specific temperature, input voltage and output current values or specified over Line, Load and Temperature ranges.

Line Regulation

The change in output voltage for a change in input voltage measured for specific output current over operating ambient temperature range.

Load Regulation

The change in output voltage for a change in output current measured for specific input voltage over operating ambient temperature range.

Dropout Voltage

The input to output differential at which the regulator output no longer maintains regulation against further reductions in input voltage. It is measured when the output drops 100 mV below its nominal value. The junction temperature, load current, and minimum input supply requirements affect the dropout level.

Quiescent Current

Quiescent Current (I_q) is the difference between the input current (measured through the LDO input pin) and the output load current.

Current Limit and Short Circuit Current Limit

Current Limit is value of output current by which output voltage drops below 96% of its nominal value. It means that the device is capable to supply minimum 200 mA without sending Reset signal to microprocessor.

Short Circuit Current Limit is output current value measured with output of the regulator shorted to ground.

PSRR

Power Supply Rejection Ratio is defined as ratio of output voltage and input voltage ripple. It is measured in decibels (dB).

Line Transient Response

Typical output voltage overshoot and undershoot response when the input voltage is excited with a given slope.

Load Transient Response

Typical output voltage overshoot and undershoot response when the output current is excited with a given slope between low-load and high-load conditions.

Thermal Protection

Internal thermal shutdown circuitry is provided to protect the integrated circuit in the event that the maximum junction temperature is exceeded. When activated at typically 175°C, the regulator turns off. This feature is provided to prevent failures from accidental overheating.

Maximum Package Power Dissipation

The power dissipation level is maximum allowed power dissipation for particular package or power dissipation at which the junction temperature reaches its maximum operating value, whichever is lower.

APPLICATIONS INFORMATION

The NCV8669 regulator is self-protected with internal thermal shutdown and internal current limit. Typical characteristics are shown in Figures 4 to 25.

Input Decoupling (C_{in})

A ceramic or tantalum 0.1 μ F capacitor is recommended and should be connected close to the NCV8669 package. Higher capacitance and lower ESR will improve the overall line and load transient response.

If extremely fast input voltage transients are expected then appropriate input filter must be used in order to decrease rising and/or falling edges below 50 V/ μ s for proper operation. The filter can be composed of several capacitors in parallel.

Output Decoupling (C_{out})

The NCV8669 is a stable component and does not require a minimum Equivalent Series Resistance (ESR) for the output capacitor. Stability region of ESR versus Output Current is shown in Figure 13. The minimum output decoupling value is 2.2 μ F and can be augmented to fulfill stringent load transient requirements. The regulator works with ceramic chip capacitors as well as tantalum devices. Larger values improve noise rejection and load transient response.

Reset Delay Time Select

Selection of the NCV8669yz devices and the state of the DT pin determines the available Reset Delay times. The part is designed for use with DT tied to ground or OUT, but may be controlled by any logic signal which provides a threshold

between 0.8 V and 2 V. The default condition for an open DT pin is the faster Reset time (DT = GND condition). Times are in pairs and are highlighted in the table below. Consult factory for availability. The Delay Time select (DT) pin is logic level controlled and provides Reset Delay time per the table. Note the DT pin is sampled only when RO is low, and changes to the DT pin when RO is high will not effect the reset delay time.

Reset Operation

A reset signal is provided on the Reset Output (RO) pin to provide feedback to the microprocessor of an out of regulation condition. The timing diagram of reset function is shown in Figure 24. This is in the form of a logic signal on RO. Output voltage conditions below the RESET threshold cause RO to go low. The RO integrity is maintained down to $V_{out} = 1.0$ V. The Reset Output (RO) circuitry includes internal pull-up connected to the output (V_{out}) No external pull-up is necessary.

RESET DELAY AND RESET THRESHOLD OPTIONS

Part Number	DT = GND Reset Time	DT = V_{out} Reset Time	Reset Threshold
NCV86695z	16 ms	32 ms	93%

NOTE: The timing values can be selected from following list: 8, 16, 32, 64, and 128 ms. The reset threshold values can be selected from following list: 90% and 93%. Contact factory for other timing and reset thresholds combinations not included in the table.

Sense Input (SI) / Sense Output (SO) Voltage Monitor

An on-chip comparator is available to provide early warning to the microprocessor of a possible reset signal (Figure 25). The Sense Output is from an open drain driver with an internal 30 kΩ pull up resistor to V_{out}. The reset signal typically turns the microprocessor off instantaneously. This can cause unpredictable results with the microprocessor. The signal received from the SO pin will allow the microprocessor time (t_{Warning}) to complete its present task before shutting down. The actual trip point of input voltage is programmed by internal resistor divider and external resistor R_{SI_ext}. If R_{SI_ext} is not used following Preset Early Warning Threshold would apply:

EARLY WARNING PRESET OPTIONS

Part Number	R _{SI1} (Internal)	R _{SI2} (Internal)	Input Voltage Early Warning Threshold Low (Typ) (R _{SI_ext} not used)
NCV8669y2	480 kΩ	520 kΩ	2.37 V

NOTE: Contact factory for other EW Preset Options combinations not included in the table.

Practically only preset options above 4.5 V can be used without R_{SI_ext} due to minimum operating input voltage value limitation. For other preset options the trip point has to be adjusted externally using R_{SI_ext} resistor connected between input monitor SI and GND (see Figure 1). For other preset options R_{SI_ext} has to be used to achieve V_{in_EW(th)} > 5.5 V (minimum operating input voltage value). The value for R_{SI_ext} is recommended to be selected in range from 50 kΩ to 250 kΩ and the trip point can be shifted according to Figure 22. The higher is R_{SI_ext} the lower is overall Quiescent Current of the application (see Figure 23). General formulas for calculation of V_{in_EW(th)Low} or R_{SI_ext} for selected preset Early Warning options are described by Equations 1 and 2.

$$V_{in_EW(th)Low} = 1.1 \left[1 + \frac{R_{SI1} \times (R_{SI2} + R_{SI_ext})}{R_{SI2} \times R_{SI_ext}} \right] + 0.25 \quad (eq. 1)$$

$$R_{SI_ext} = 1.1 \left[\frac{R_{SI1} \times R_{SI2}}{R_{SI2} \times (V_{in_EW(th)Low} - 0.25)} - 1.1 \times 10^6 \right] \quad (eq. 2)$$

Where:

- R_{SI1}, R_{SI2} – internal EW divider resistors (see Figure 2) (select values from Early Warning Preset Options table)
- R_{SI_ext} – external resistor connected between SI and GND (recommended to be selected from 50 kΩ to 250 kΩ)

Thermal Considerations

As power in the NCV8669 increases, it might become necessary to provide some thermal relief. The maximum power dissipation supported by the device is dependent upon board design and layout. Mounting pad configuration on the PCB, the board material, and the ambient temperature affect the rate of junction temperature rise for the part. When the NCV8669 has good thermal conductivity through the PCB, the junction temperature will be relatively low with high power applications. The maximum dissipation the NCV8669 can handle is given by:

$$P_{D(MAX)} = \frac{[T_{J(MAX)} - T_A]}{R_{\theta JA}} \quad (eq. 3)$$

Since T_J is not recommended to exceed 150°C, then the NCV8669 soldered on 645 mm², 1 oz copper area, FR4 can dissipate up to 1.33 W when the ambient temperature (T_A) is 25°C. See Figure 26 for R_{thJA} versus PCB area. The power dissipated by the NCV8669 can be calculated from the following equations:

$$P_D \approx V_{in}(I_q @ I_{out}) + I_{out}(V_{in} - V_{out}) \quad (eq. 4)$$

or

$$V_{in(MAX)} \approx \frac{P_{D(MAX)} + (V_{out} \times I_{out})}{I_{out} + I_q} \quad (eq. 5)$$

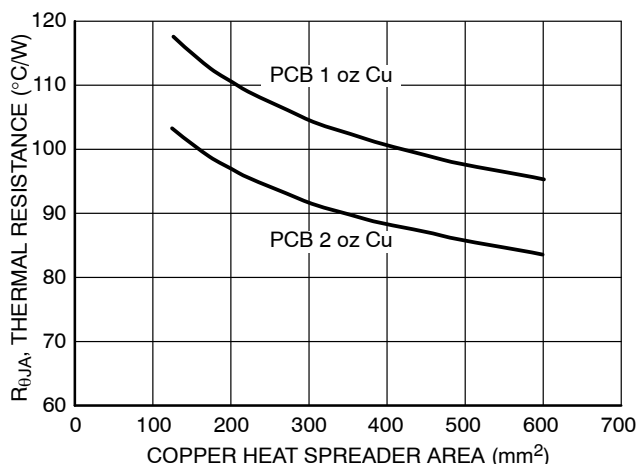

Figure 26. Thermal Resistance vs. PCB Copper Area

Hints

V_{in} and GND printed circuit board traces should be as wide as possible. When the impedance of these traces is high, there is a chance to pick up noise or cause the regulator to malfunction. Place external components, especially the output capacitor, as close as possible to the NCV8669 and make traces as short as possible.

NCV8669

ORDERING INFORMATION

Device	Output Voltage	Reset Delay Time DT = GND/V _{out}	Reset Threshold (Typ)	Input Voltage Early Warning Threshold Low (Typ) R _{SI_ext} = 150 k Ω	Marking	Package	Shipping [†]
NCV866952D250R2G	5.0 V	16 / 32 ms	93%	5.89 V	V86695250G	SO-14 (Pb-Free)	2500 / Tape & Reel

[†]For information on tape and reel specifications, including part orientation and tape sizes, please refer to our Tape and Reel Packaging Specifications Brochure, BRD8011/D

NCV8669

PACKAGE DIMENSIONS

SOIC-14
CASE 751A-03
ISSUE J

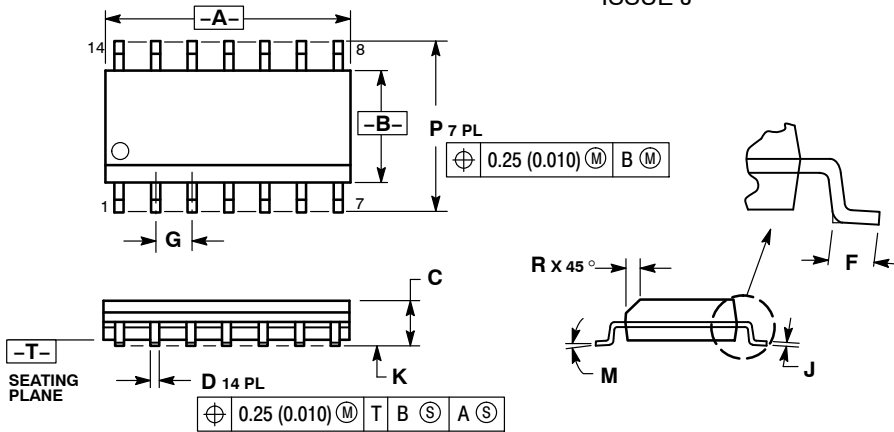

NOTES:

1. DIMENSIONING AND TOLERANCING PER ANSI Y14.5M, 1982.
2. CONTROLLING DIMENSION: MILLIMETER.
3. DIMENSIONS A AND B DO NOT INCLUDE MOLD PROTRUSION.
4. MAXIMUM MOLD PROTRUSION 0.15 (0.006) PER SIDE.
5. DIMENSION D DOES NOT INCLUDE DAMBAR PROTRUSION. ALLOWABLE DAMBAR PROTRUSION SHALL BE 0.127 (0.005) TOTAL IN EXCESS OF THE D DIMENSION AT MAXIMUM MATERIAL CONDITION.

DIM	MILLIMETERS		INCHES	
	MIN	MAX	MIN	MAX
A	8.55	8.75	0.337	0.344
B	3.80	4.00	0.150	0.157
C	1.35	1.75	0.054	0.068
D	0.35	0.49	0.014	0.019
F	0.40	1.25	0.016	0.049
G	1.27 BSC		0.050 BSC	
J	0.19	0.25	0.008	0.009
K	0.10	0.25	0.004	0.009
M	0°	7°	0°	7°
P	5.80	6.20	0.228	0.244
R	0.25	0.50	0.010	0.019

SOLDERING FOOTPRINT*

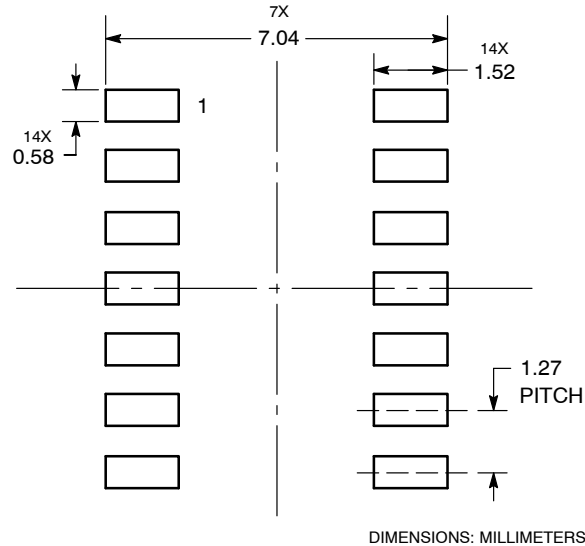

*For additional information on our Pb-Free strategy and soldering details, please download the ON Semiconductor Soldering and Mounting Techniques Reference Manual, SOLDERRM/D.

ON Semiconductor and are registered trademarks of Semiconductor Components Industries, LLC (SCILLC). SCILLC reserves the right to make changes without further notice to any products herein. SCILLC makes no warranty, representation or guarantee regarding the suitability of its products for any particular purpose, nor does SCILLC assume any liability arising out of the application or use of any product or circuit, and specifically disclaims any and all liability, including without limitation special, consequential or incidental damages. "Typical" parameters which may be provided in SCILLC data sheets and/or specifications can and do vary in different applications and actual performance may vary over time. All operating parameters, including "Typicals" must be validated for each customer application by customer's technical experts. SCILLC does not convey any license under its patent rights nor the rights of others. SCILLC products are not designed, intended, or authorized for use as components in systems intended for surgical implant into the body, or other applications intended to support or sustain life, or for any other application in which the failure of the SCILLC product could create a situation where personal injury or death may occur. Should Buyer purchase or use SCILLC products for any such unintended or unauthorized application, Buyer shall indemnify and hold SCILLC and its officers, employees, subsidiaries, affiliates, and distributors harmless against all claims, costs, damages, and expenses, and reasonable attorney fees arising out of, directly or indirectly, any claim of personal injury or death associated with such unintended or unauthorized use, even if such claim alleges that SCILLC was negligent regarding the design or manufacture of the part. SCILLC is an Equal Opportunity/Affirmative Action Employer. This literature is subject to all applicable copyright laws and is not for resale in any manner.

PUBLICATION ORDERING INFORMATION

LITERATURE FULFILLMENT:
Literature Distribution Center for ON Semiconductor
P.O. Box 5163, Denver, Colorado 80217 USA
Phone: 303-675-2175 or 800-344-3860 Toll Free USA/Canada
Fax: 303-675-2176 or 800-344-3867 Toll Free USA/Canada
Email: orderlit@onsemi.com

N. American Technical Support: 800-282-9855 Toll Free USA/Canada
Europe, Middle East and Africa Technical Support:
Phone: 421 33 790 2910
Japan Customer Focus Center
Phone: 81-3-5773-3850

ON Semiconductor Website: www.onsemi.com
Order Literature: <http://www.onsemi.com/orderlit>
For additional information, please contact your local Sales Representative